

| | |
|-----------------------|------------|
| ΑΡΙΘΜΟΣ ΠΥΛΩΝΑ | 36Α |
| ΑΡΙΘΜΟΣ ΦΩΤΙΣΤΙΚΩΝ | 24 |
| ΗΜΕΡΟΜΗΝΙΑ ΣΥΝΤΗΡΗΣΗΣ | 15/09/2024 |

ΠΙΝΑΚΑΣ ΑΝΤΙΣΤΟΙΧΗΣΗΣ-ΣΗΜΑΝΣΗΣ

| Φωτιστικό | Group | Κλέμμα-Πίνακας Στεφάνης | Pin-Out Φίσας (24-Pin) | Κλέμμα-Πίνακας εντός Πυλώνα | Κλέμμα Κεντρικού Πίνακα |
|-----------|-------|-------------------------|------------------------|-----------------------------|-------------------------|
| 1UG1 | 1 | 11 | 12 | 11 | 11 |
| 1DG1 | 1 | 11 | 12 | 11 | 11 |
| 2UG1 | 1 | 11 | 12 | 11 | 11 |
| 2DG1 | 1 | 11 | 12 | 11 | 11 |
| 3UG1 | 2 | 22 | 34 | 22 | 22 |
| 3DG1 | 2 | 22 | 34 | 22 | 22 |
| 4UG1 | 2 | 22 | 34 | 22 | 22 |
| 4DG1 | 2 | 22 | 34 | 22 | 22 |
| 5UG2 | 3 | 33 | 56 | 33 | 33 |
| 5DG2 | 3 | 33 | 56 | 33 | 33 |
| 6UG2 | 3 | 33 | 56 | 33 | 33 |
| 6DG2 | 3 | 33 | 56 | 33 | 33 |
| 7UG2 | 4 | 44 | 78 | 44 | 44 |
| 7DG2 | 4 | 44 | 78 | 44 | 44 |
| 8UG2 | 4 | 44 | 78 | 44 | 44 |
| 8DG2 | 4 | 44 | 78 | 44 | 44 |
| 9UG3 | 5 | 55 | 9-10 | 55 | 55 |
| 9DG3 | 5 | 55 | 9-10 | 55 | 55 |
| 10UG3 | 5 | 55 | 9-10 | 55 | 55 |
| 10DG3 | 5 | 55 | 9-10 | 55 | 55 |
| 11UG3 | 6 | 66 | 11-12 | 66 | 66 |
| 11DG3 | 6 | 66 | 11-12 | 66 | 66 |
| 12UG3 | 6 | 66 | 11-12 | 66 | 66 |
| 12DG3 | 6 | 66 | 11-12 | 66 | 66 |

- Η αρίθμηση των φωτιστικών ξεκινάει από το κεντρικό κουτί της στεφάνης (inox) δεξιόστροφα με τη φορά του ρολογιού.
Π.χ. 1UG1 → Φωτιστικό Ν° 1 αριστερά του κουτιού, UP, ανήκει στο Group 1.

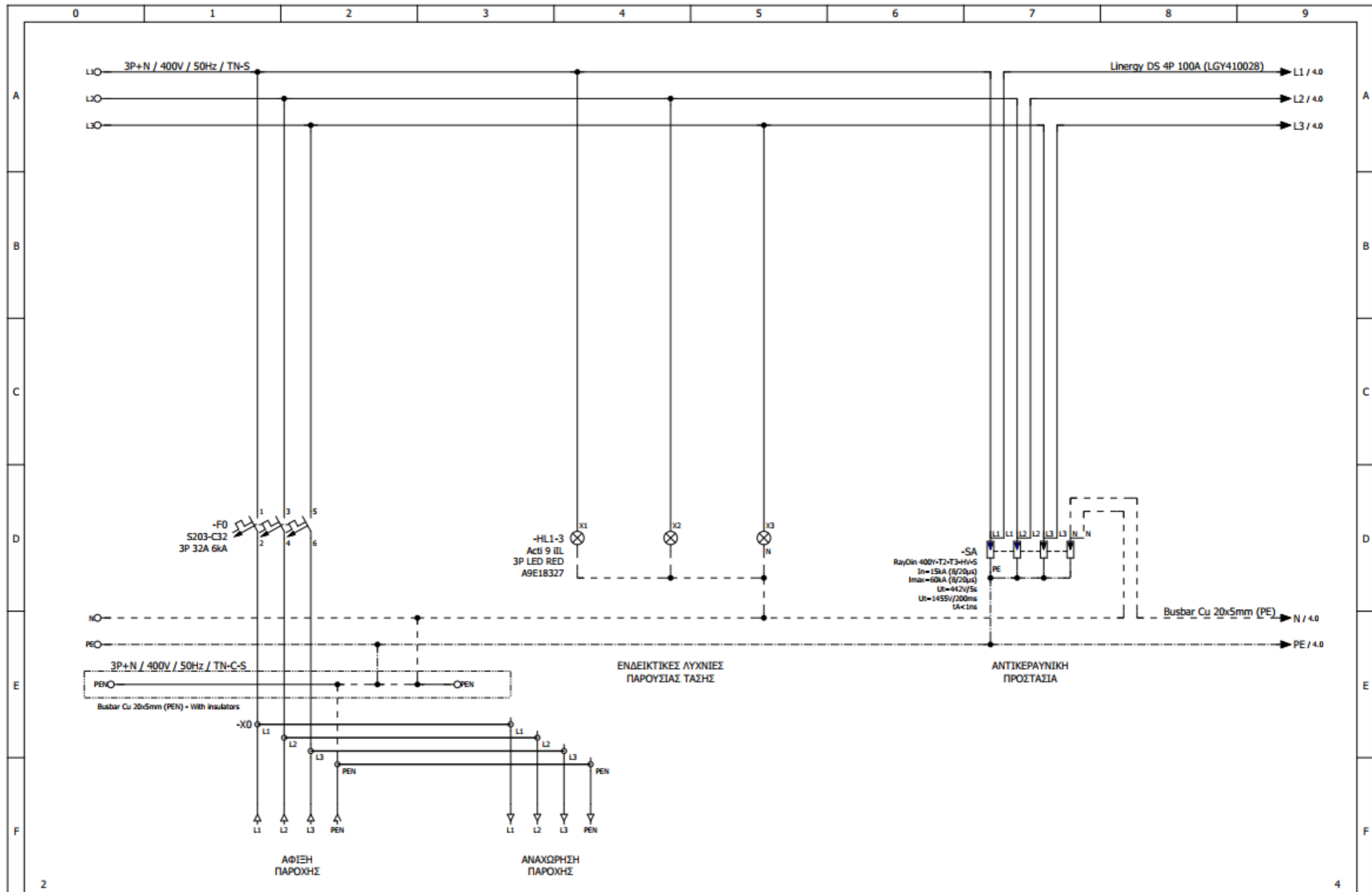

| | | | | | | | | | |
|----------|------|---------------------------|------|-----------------------------|---|--------------------------------------|------------------------|--------------|--|
| | | Designed C.CHRISOSTOMIDIS | | Customer: BI AUTOMATIONS | Page description: ΕΙΣΟΔΟΣ ΠΑΡΟΧΗΣ | Panel: ΠΙΝΑΚΑΣ ΠΥΛΩΝΑΣ ΦΩΤΙΣΜΟΥ Νο19 | | Function: = | |
| | | Checked C.CHRISOSTOMIDIS | | | | Panel serial number: --- | | Location: + | |
| | | Approved C.CHRISOSTOMIDIS | | | | Doc No: --- | | Structure: & | |
| Revision | Date | Description | Date | 20/2/2024 | Project: ΟΡΓΑΝΙΣΜΟΣ ΛΙΜΕΝΟΣ ΘΕΣΣΑΛΟΝΙΚΗΣ | Order No: --- | Page: 3 | | |
| | | | | | | Contract No: --- | Sheet / Out of: 3 / 12 | | |

SEBrouchous reserves all rights in this document and the information contained therein. Reproduction, use or disclosure to third parties without express authority is strictly forbidden.

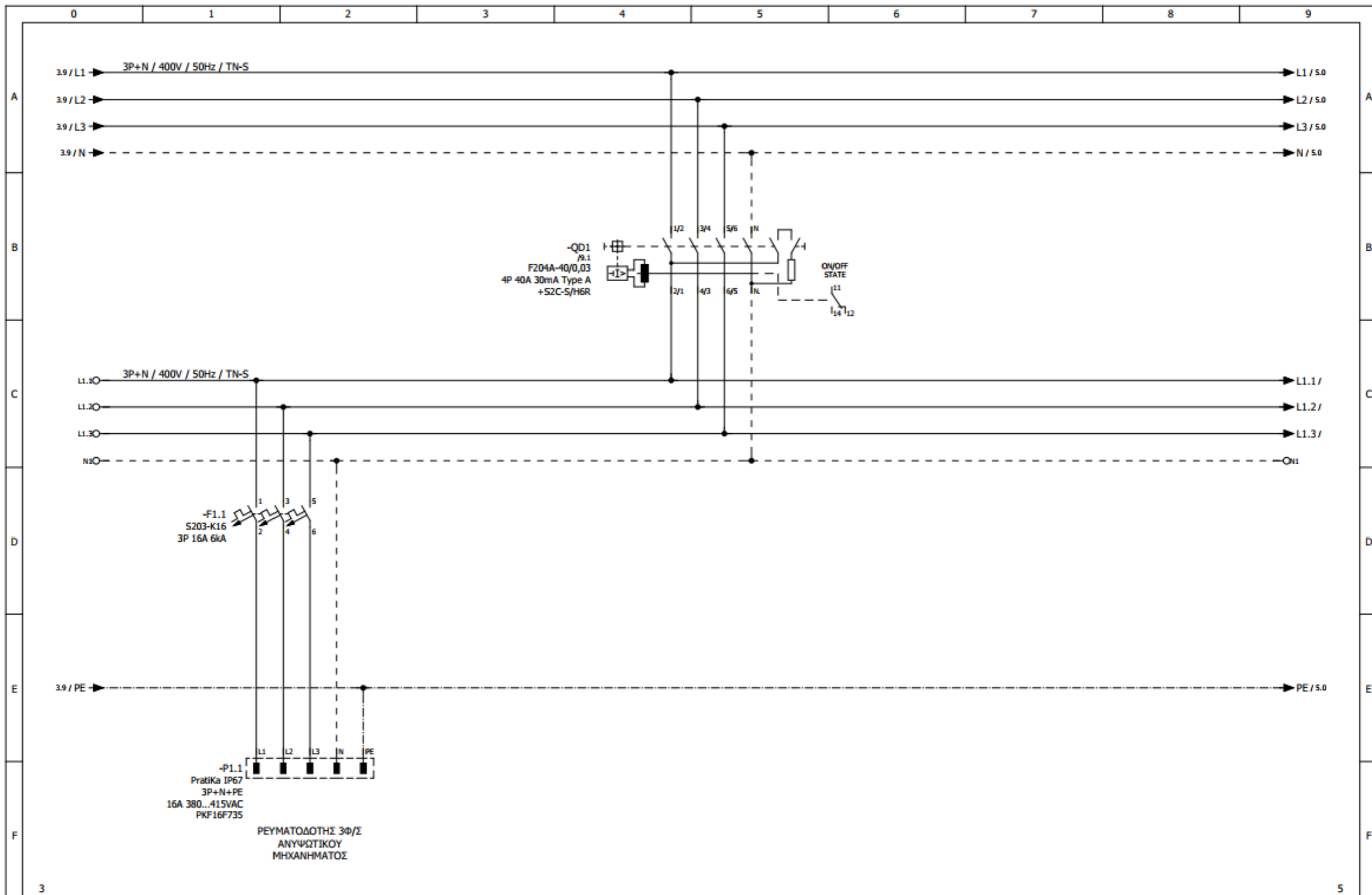

| | | | | | | | | | | | |
|----------|--|---------------------------|--|---|--|-------------------------------------|--|--------------------------------------|--|------------------------|--|
| 3 | | 5 | | Customer: BI AUTOMATIONS | | Page description: ΚΥΚΛΩΜΑ ΙΣΧΥΟΣ | | Panel: ΠΙΝΑΚΑΣ ΠΥΛΩΝΑΣ ΦΩΤΙΣΜΟΥ Νο49 | | Function: = | |
| | | Designed C.CHRISOSTOMIDIS | | Project: ΟΡΓΑΝΙΣΜΟΣ ΛΙΜΕΝΟΣ ΘΕΣΣΑΛΟΝΙΚΗΣ | | | | Panel serial number: --- | | Location: + | |
| | | Checked C.CHRISOSTOMIDIS | | | | | | Doc No: --- | | Structure: & | |
| | | Approved C.CHRISOSTOMIDIS | | | | | | Order No: --- | | Page: 4 | |
| Revision | | Date | | Date | | 20/2/2024 | | Contract No: --- | | Sheet / Out of: 4 / 12 | |

SEBtechniques reserves all rights in this document and the information contained therein. Reproduction, use or disclosure to third parties without express authority is strictly forbidden.

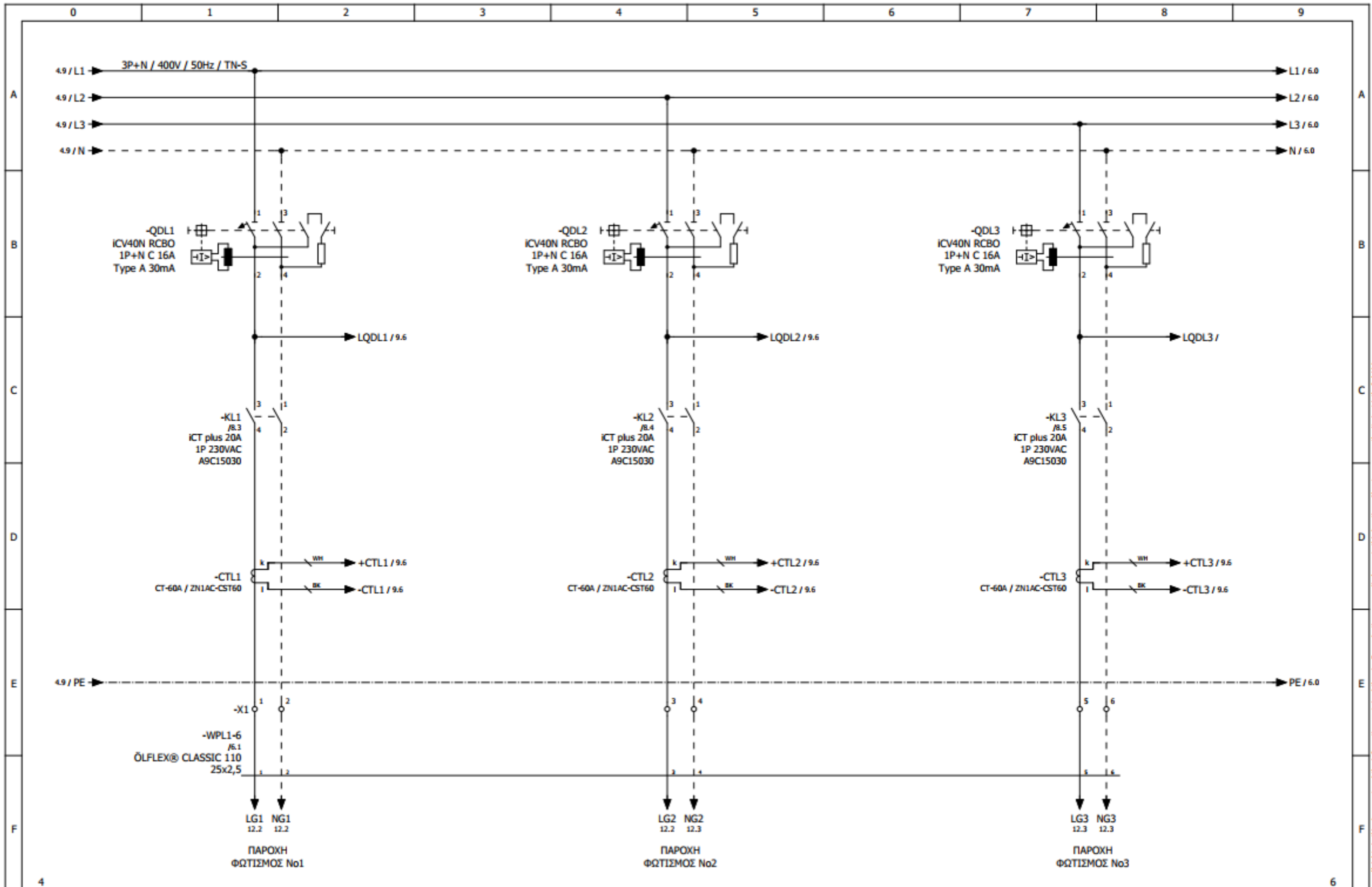

| | | | | | | | | | |
|-----------------|--|------------------|-------------|--------------|-----------|---------------------------------|-------------------------------------|--------------------------------------|------------------------|
| Revision | | Date | Description | Date | 20/2/2024 | Customer: BI AUTOMATIONS | Page description: ΚΥΚΛΩΜΑ ΙΣΧΥΟΣ | Panel: ΠΙΝΑΚΑΣ ΠΥΛΩΝΑΣ ΦΩΤΙΣΜΟΥ Νο49 | Function: = |
| Designed | | C.CHRISOSTOMIDIS | | Checked | | C.CHRISOSTOMIDIS | | Panel serial number: --- | Location: + |
| Approved | | C.CHRISOSTOMIDIS | | Project: | | ΟΡΓΑΝΙΣΜΟΣ ΛΙΜΕΝΟΣ ΘΕΣΣΑΛΟΝΙΚΗΣ | | Doc No: --- | Structure: & |
| Order No: | | --- | | Contract No: | | --- | | Order No: --- | Page: 5 |
| Sheet / Out of: | | 5 / 12 | | | | | | Contract No: --- | Sheet / Out of: 5 / 12 |

SBTechniques reserves all rights in this document and the information contained therein. Reproduction, use or disclosure to third parties without express authority is strictly forbidden.

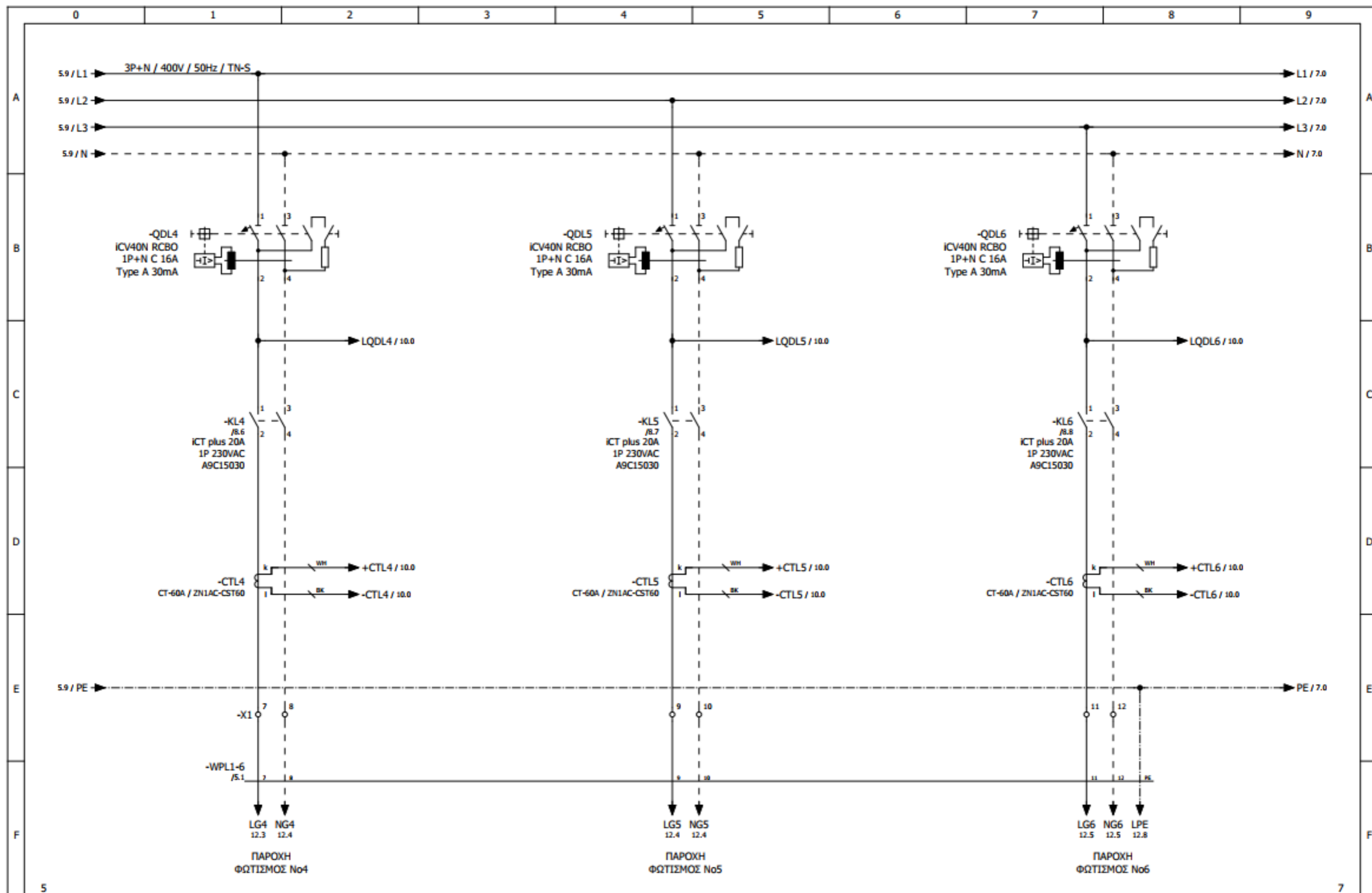

| | | | | | | | | | |
|----------|--|------|------------------------------|------|-----------|--|--|--------------------------------------|------------------------|
| Revision | | Date | Description | Date | 20/2/2024 | Customer: BI AUTOMATIONS Project: ΟΡΓΑΝΙΣΜΟΣ ΛΙΜΕΝΟΣ ΘΕΣΣΑΛΟΝΙΚΗΣ | Page description: ΚΥΚΛΩΜΑ ΙΣΧΥΟΣ | Panel: ΠΙΝΑΚΑΣ ΠΥΛΩΝΑΣ ΦΩΤΙΣΜΟΥ Νο49 | Function: = |
| | | | Designed C.CHRISOSTOMIDIS | | | | | Panel serial number: --- | Location: + |
| | | | Checked C.CHRISOSTOMIDIS | | | | | Doc No: --- | Structure: & |
| | | | Approved C.CHRISOSTOMIDIS | | | | | Order No: --- | Page: 6 |
| | | | | | | | | Contract No: --- | Sheet / Out of: 6 / 12 |

SEPractiques reserves all rights in this document and the information contained therein. Reproduction, use or disclosure to third parties without express authority is strictly forbidden.

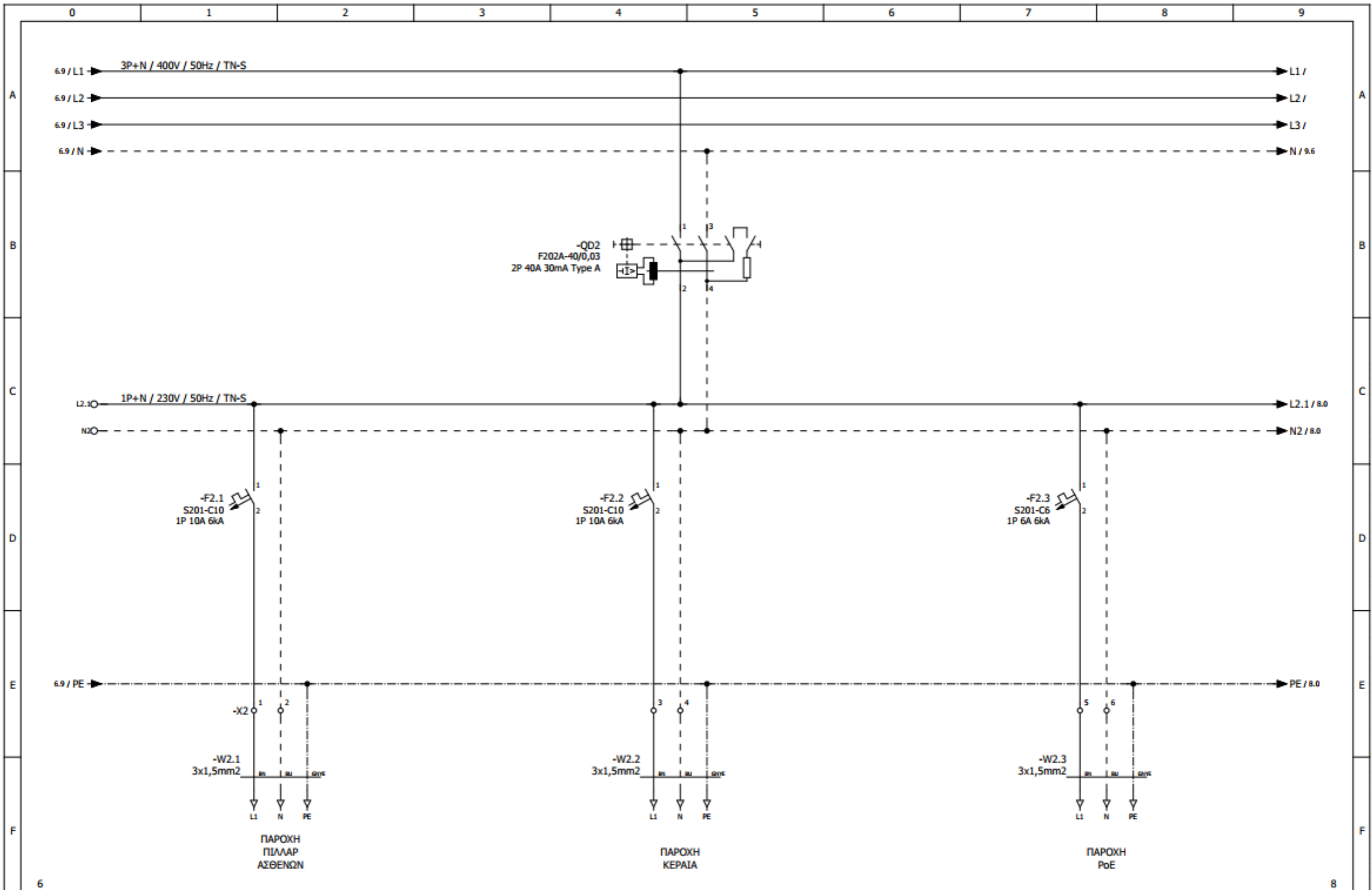

| | | | | | | | | |
|----------|------|-------------|----------|------------------|---|-------------------------------------|--------------------------------------|------------------------|
| Revision | Date | Description | Date | 20/2/2024 | Customer: BI AUTOMATIONS | Page description: ΚΥΚΛΩΜΑ ΙΣΧΥΟΣ | Panel: ΠΙΝΑΚΑΣ ΠΥΛΩΝΑΣ ΦΩΤΙΣΜΟΥ Νο49 | Function: = |
| | | | Designed | C.CHRISOSTOMIDIS | Project: ΟΡΓΑΝΙΣΜΟΣ ΛΙΜΕΝΟΣ ΘΕΣΣΑΛΟΝΙΚΗΣ | | Panel serial number: --- | Location: + |
| | | | Checked | C.CHRISOSTOMIDIS | | | Doc No: --- | Structure: & |
| | | | Approved | C.CHRISOSTOMIDIS | | | Order No: --- | Page: 7 |
| | | | | | | | Contract No: --- | Sheet / Out of: 7 / 12 |

SBTechniques reserves all rights in this document and the information contained therein. Reproduction, use or disclosure to third parties without express authority is strictly forbidden.

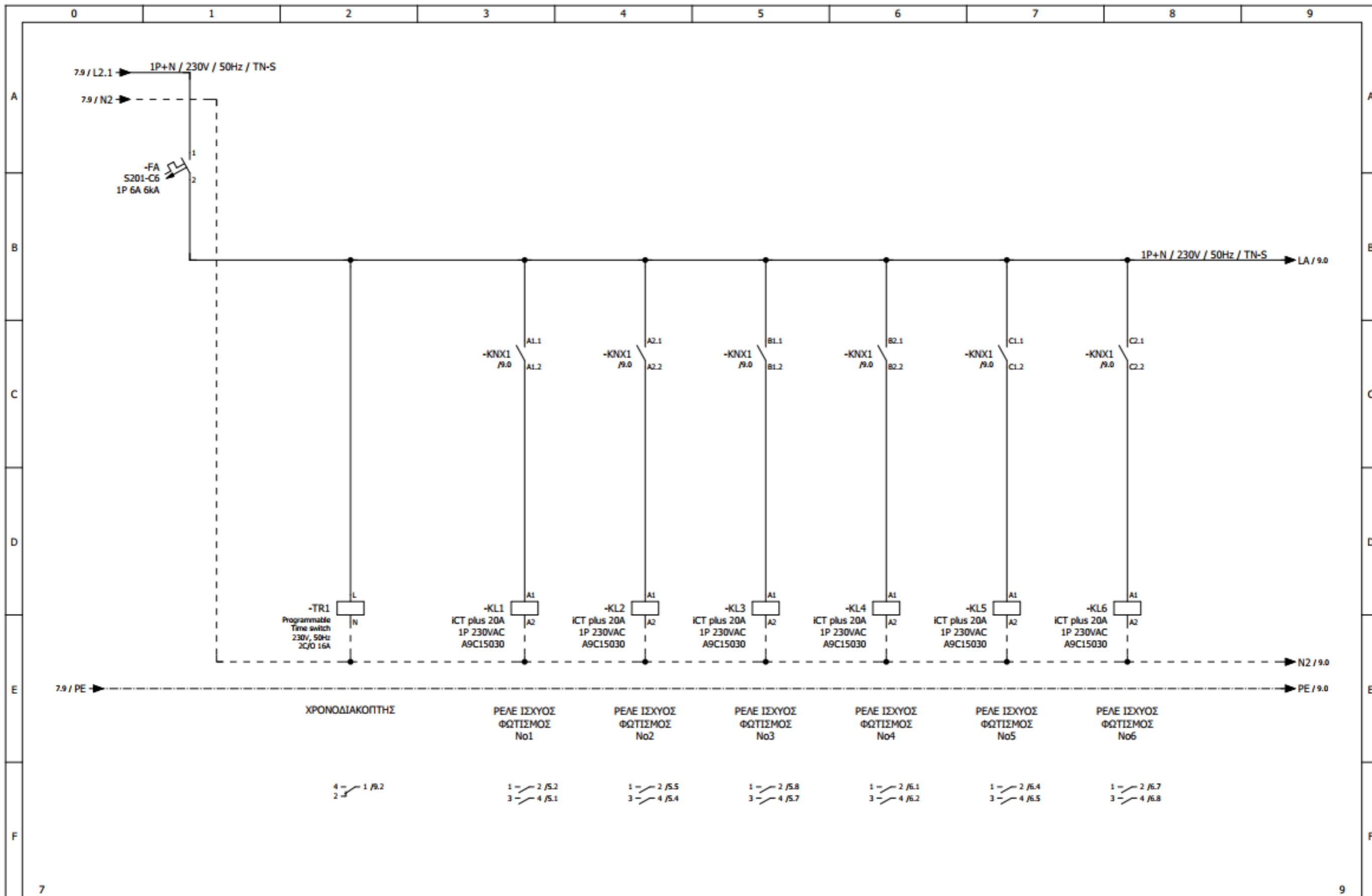

| | | | |
|--------------------------------------|------------------|------------------------|---------------------------------|
| 7 | | 9 | |
| Designed | C.CHRISOSTOMIDIS | Customer: | BI AUTOMATIONS |
| Checked | C.CHRISOSTOMIDIS | Project: | ΟΡΓΑΝΙΣΜΟΣ ΛΙΜΕΝΟΣ ΘΕΣΣΑΛΟΝΙΚΗΣ |
| Approved | C.CHRISOSTOMIDIS | Page description: | ΑΥΤΟΜΑΤΙΣΜΟΣ |
| Revision | Date | Description | Date |
| | 20/2/2024 | | |
| Panel: ΠΙΝΑΚΑΣ ΠΥΛΩΝΑΣ ΦΩΤΙΣΜΟΥ Νο99 | | Function: = | |
| Panel serial number: --- | | Location: + | |
| Doc No: --- | | Structure: & | |
| Order No: --- | | Page: 8 | |
| Contract No: --- | | Sheet / Out of: 8 / 12 | |

SEProtechniques reserves all rights in this document and the information contained therein. Reproduction, use or disclosure to third parties without express authority is strictly forbidden.

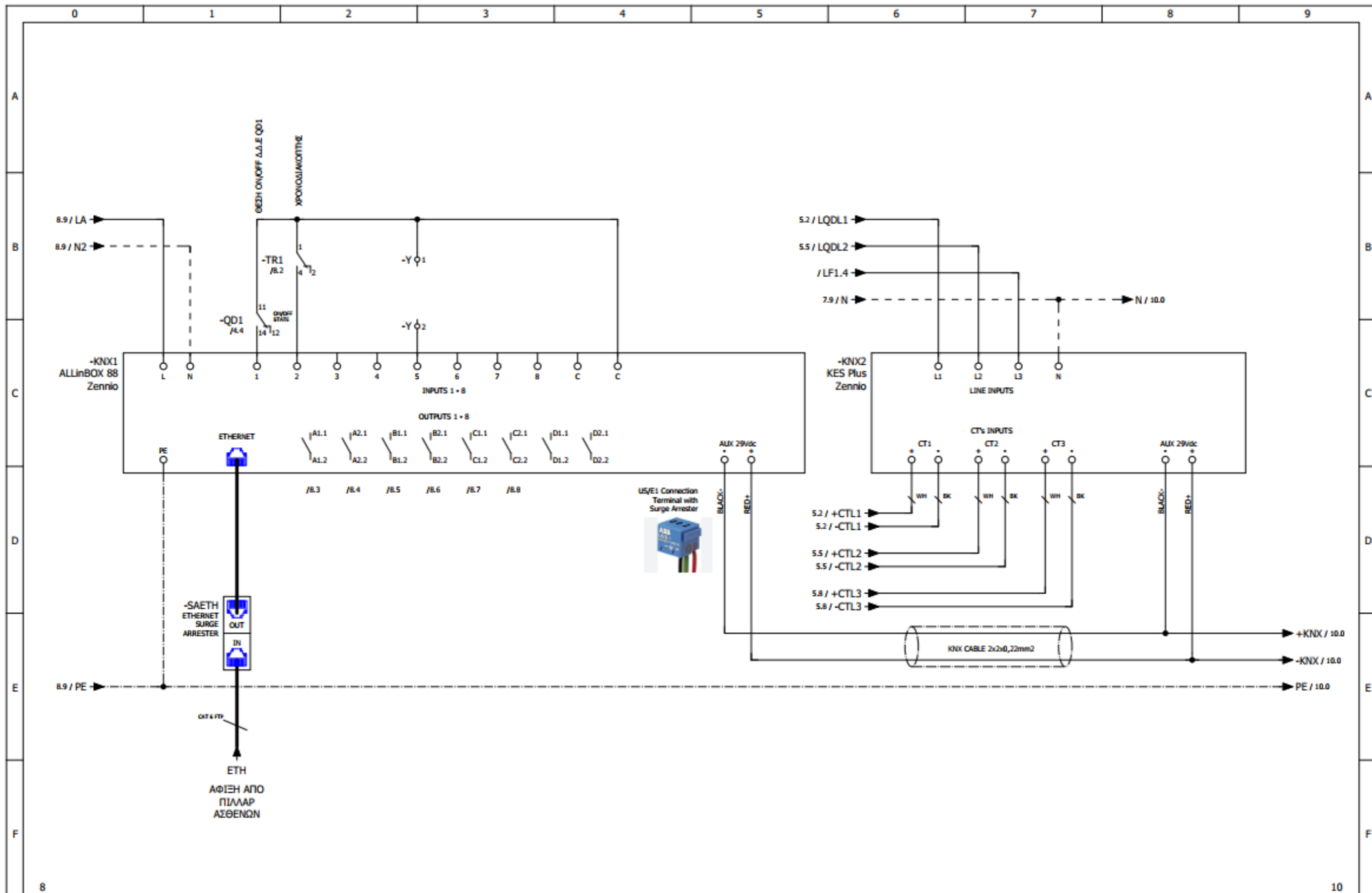

| | | | | | | | | | |
|----------|------|---------------------------|------|-----------------------------|---|--------------------------------------|---------|--------------|------------------------|
| | | Designed C.CHRISOSTOMIDIS | | Customer: BI AUTOMATIONS | Page description: ΑΥΤΟΜΑΤΙΣΜΟΣ | Panel: ΠΙΝΑΚΑΣ ΠΥΛΩΝΑΣ ΦΩΤΙΣΜΟΥ Νο49 | | Function: = | |
| | | Checked C.CHRISOSTOMIDIS | | | | Panel serial number: --- | | Location: + | |
| | | Approved C.CHRISOSTOMIDIS | | | | Doc No: --- | | Structure: & | |
| Revision | Date | Description | Date | 20/2/2024 | Project: ΟΡΓΑΝΙΣΜΟΣ ΛΙΜΕΝΟΣ ΘΕΣΣΑΛΟΝΙΚΗΣ | Order No: --- | Page: 9 | | Sheet / Out of: 9 / 12 |

SEPractiques reserves all rights in this document and the information contained therein. Reproduction, use or disclosure to third parties without express authority is strictly forbidden.

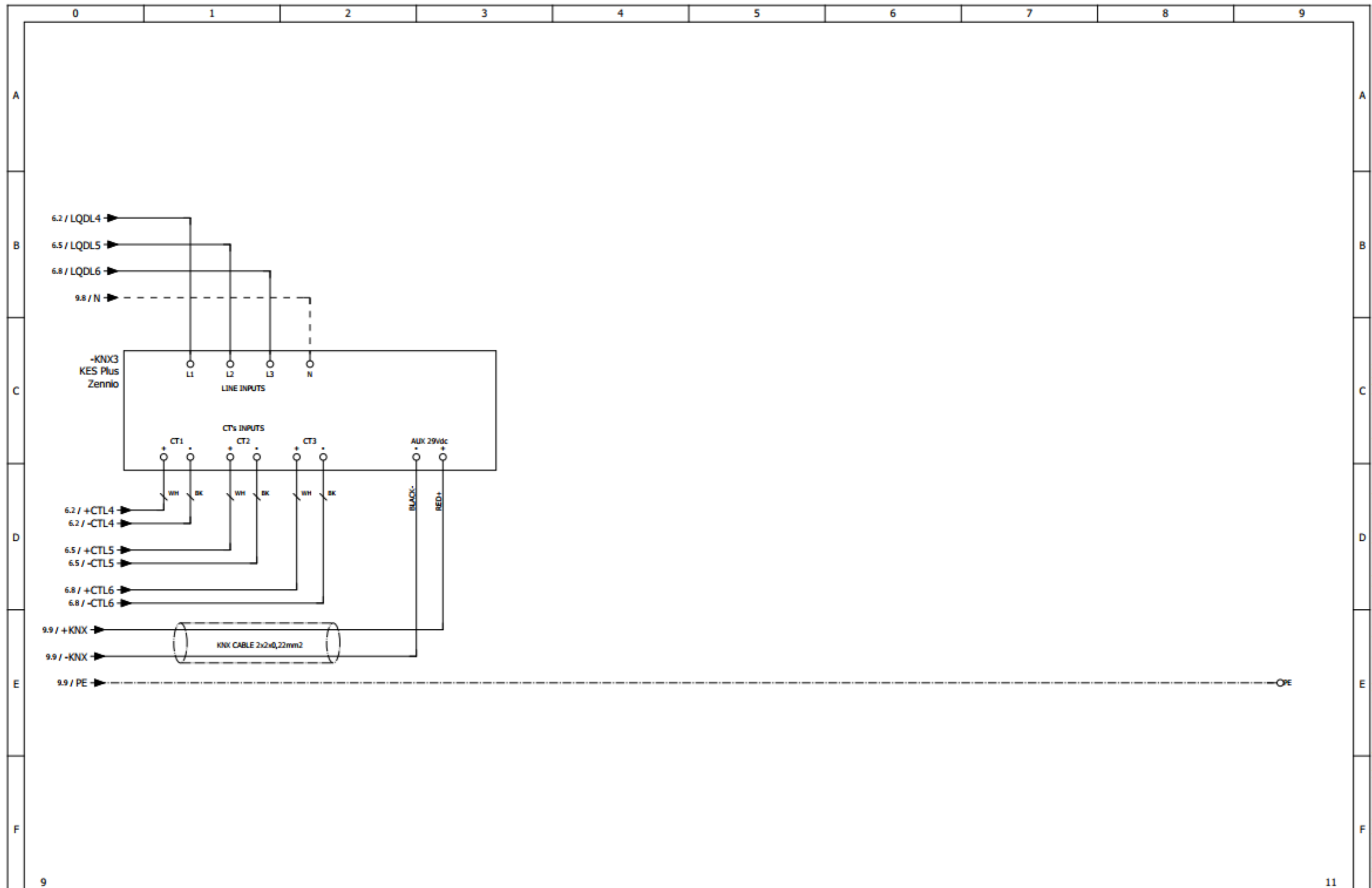

| | | | | |
|----------|------|-------------|------------------|-----------|
| 9 | | | | |
| | | Designed | C.CHRISOSTOMIDIS | |
| | | Checked | C.CHRISOSTOMIDIS | |
| | | Approved | C.CHRISOSTOMIDIS | |
| Revision | Date | Description | Date | 20/2/2024 |

Customer:
BI AUTOMATIONS

Project:
ΟΡΓΑΝΙΣΜΟΣ ΛΙΜΕΝΟΣ ΘΕΣΣΑΛΟΝΙΚΗΣ

Page description:
ΑΥΤΟΜΑΤΙΣΜΟΣ

| | |
|--------------------------------------|-------------------------|
| Panel: ΠΙΝΑΚΑΣ ΠΥΛΩΝΑΣ ΘΕΤΙΣΜΟΥ Νο49 | Function: = |
| Panel serial number: --- | Location: + |
| Doc No: --- | Structure: & |
| Order No: --- | Page: 10 |
| Contract No: --- | Sheet / Out of: 10 / 12 |

SEBtechniques reserves all rights in this document and the information contained therein. Reproduction, use or disclosure to third parties without express authority is strictly forbidden.

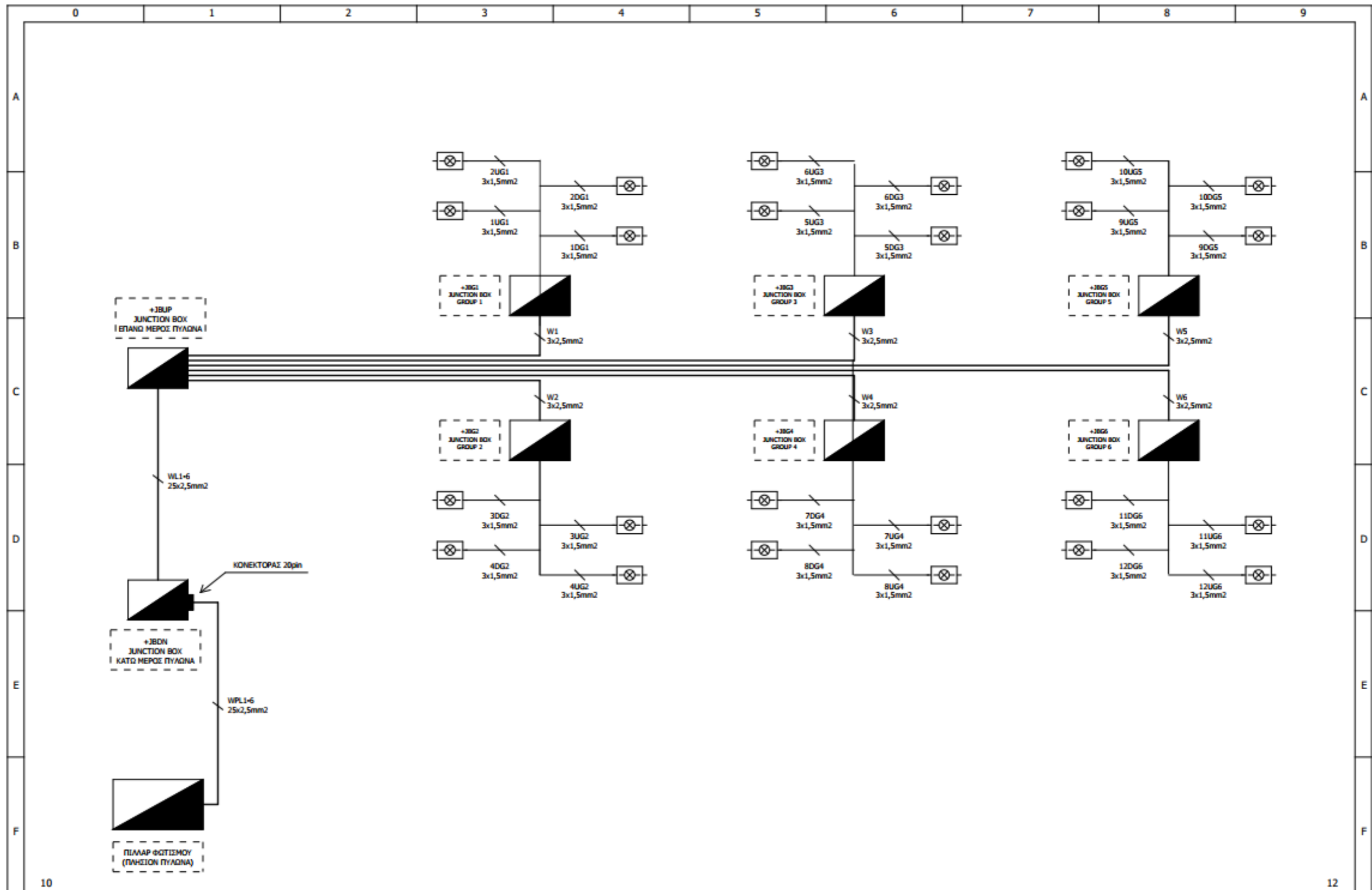

10

12

| | | | | | | | | |
|----------|------------------|-------------|---------------------------------|----------------------|-------------------------------|------------|-----------------|---------|
| Designed | C.CHRISOSTOMIDIS | Customer: | BI AUTOMATIONS | Panel: | ΠΙΝΑΚΑΣ ΠΥΛΩΝΑΣ ΦΩΤΙΣΜΟΥ Νο49 | Function: | + | |
| Checked | C.CHRISOSTOMIDIS | Project: | ΟΡΓΑΝΙΣΜΟΣ ΛΙΜΕΝΟΣ ΘΕΣΣΑΛΟΝΙΚΗΣ | Panel serial number: | --- | Location: | + | |
| Approved | C.CHRISOSTOMIDIS | | | Doc No: | --- | Structure: | & | |
| Revision | Date | Description | Date | 20/2/2024 | Order No: | --- | Page: | 11 |
| | | | | | Contract No: | --- | Sheet / Out of: | 11 / 12 |

SEITECH reserves all rights in this document and the information contained therein. Reproduction, use or disclosure to third parties without express authority is strictly forbidden.

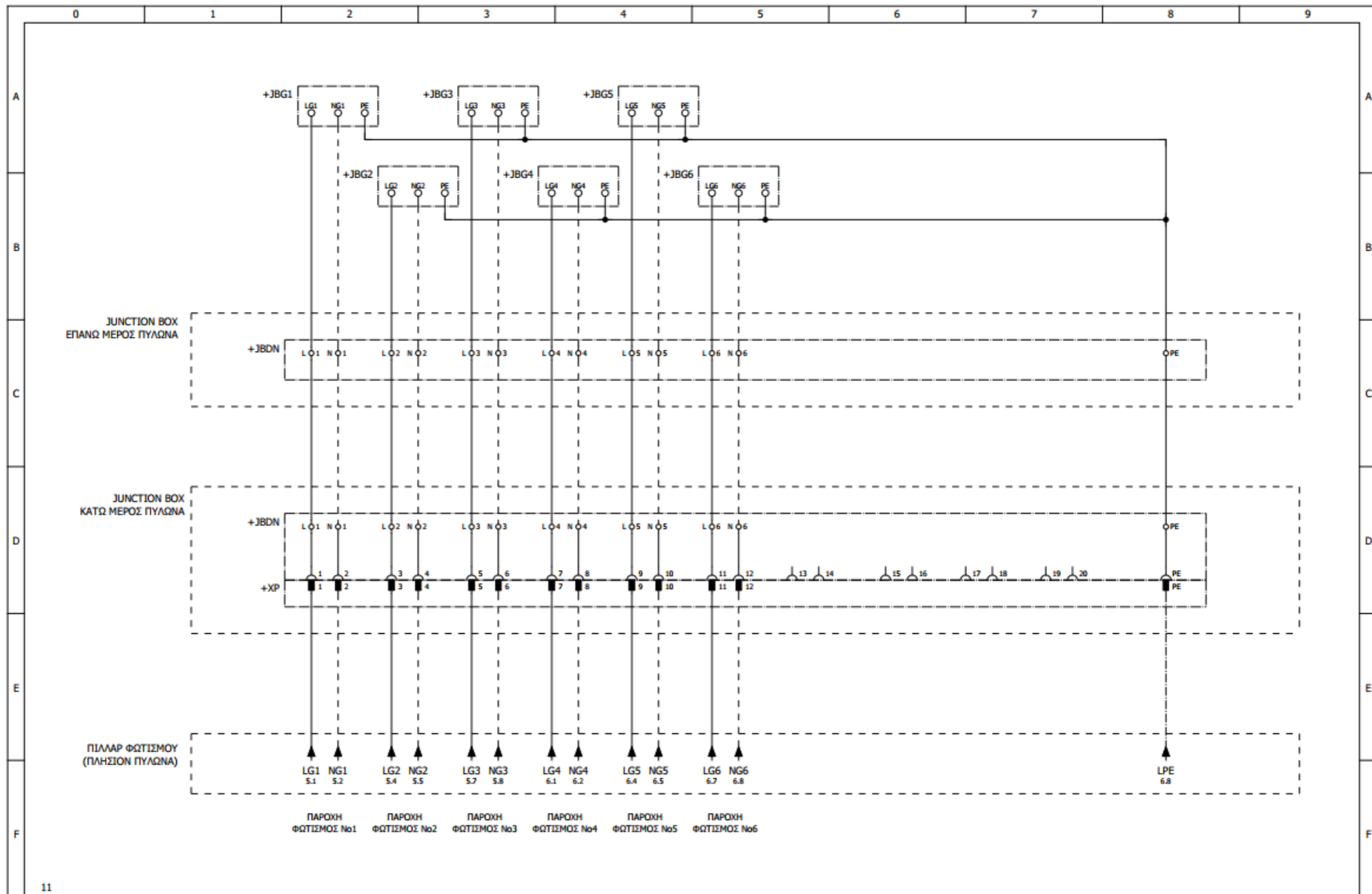

11

| | | | | | | | | |
|----------|------|-------------|------|-----------|---|--------------------------------|--------------------------------------|-------------------------|
| Revision | Date | Description | Date | 20/2/2024 | Customer: BI AUTOMATIONS | Page description: ΣΧΗΜΑΤΙΚΟ | Panel: ΠΙΝΑΚΑΣ ΠΥΛΩΝΑΣ ΦΩΤΙΣΜΟΥ Νο49 | Function: = |
| | | | | | Project: ΟΡΓΑΝΙΣΜΟΣ ΛΙΜΕΝΟΣ ΘΕΣΣΑΛΟΝΙΚΗΣ | | Panel serial number: --- | Location: + |
| | | | | | | | Doc No: --- | Structure: & |
| | | | | | | | Order No: --- | Page: 12 |
| | | | | | | | Contract No: --- | Sheet / Out of: 12 / 12 |

SBTechniques reserves all rights in this document and the information contained therein. Reproduction, use or disclosure to third parties without express authority is strictly forbidden.